

Product Data

Split System Cooling

4A7A4018N1000A/B	4A7A4018L1000A
4A7A4019N1000A	4A7A4024L1000A
4A7A4024N1000A/B	4A7A4025L1000B
4A7A4025N1000A/B	4A7A4030L1000A/B
4A7A4030N1000A	4A7A4031L1000A/B
4A7A4036N1000A	4A7A4036L1000A/B
4A7A4042N1000A	4A7A4036M1000A
4A7A4048N1000A	4A7A4037L1000A/B
4A7A4049N1000A	4A7A4037M1000A
4A7A4060N1000A	4A7A4042L1000A
	4A7A4043L1000A
	4A7A4048L1000A
	4A7A4060L1000A

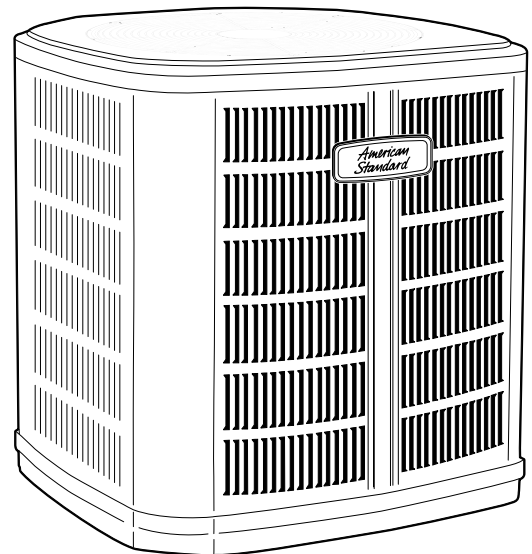

Note: "Graphics in this document are for representation only. Actual model may differ in appearance."

Product Specifications

Model No. ^(a)	4A7A4018N1000A\ 4A7A4018N1000B	4A7A4019N1000A	4A7A4024N1000A\ 4A7A4024N1000B
POWER CONNS. — V/PH/HZ ^(b)	208/230/1/60	208/230/1/60	208/230/1/60
MIN. BRCH. CIR. AMPACITY	13 / 14	12	13 / 14
BR. CIR. PROT. RTG. — MAX. (AMPS)	20 / 25	20	20 / 25
COMPRESSOR	DURATION™ - SCROLL	DURATION™ - SCROLL	DURATION™ - SCROLL
RL AMPS — LR AMPS	10.1 — 52 / 10.9 — 62.9	9 — 47.5	10.1 — 52 / 10.9 — 62.9
Outdoor Fan FL AMPS	0.9	0.64	0.9
Fan HP	1/8	1/8	1/8
Fan Dia (inches)	18.9	23	18.9
Coil	SPINE FIN™	SPINE FIN™	SPINE FIN™
Refrigerant R-410A	4 LBS., 11 OZ	4 LBS., 15 OZ	4 LBS., 11 OZ
VALVE CONNECTION SIZE - IN. O.D. GAS	3/4	3/4	3/4
VALVE CONNECTION SIZE - IN. O.D. LIQ	3/8	3/8	3/8
LINE SIZE — IN. O.D. GAS ^(c)	3/4	3/4	3/4
LINE SIZE — IN. O.D. LIQ. ^(c)	3/8	3/8	3/8
Charge Spec. Subcooling	10°F	8°F	10°F
Dimensions H x W X D Crated (IN.)	30.1 x 26.7 x 30	34 x 30.1 x 33	30.1 x 26.7 x 30
Weight — Shipping (lbs.)	153	189	153
Weight — Net (lbs.)	133	161	133
Optional Accessories:			
Anti-short Cycle Timer	TAYASCT501A	TAYASCT501A	TAYASCT501A
Evaporator Defrost Control	AY28X079	AY28X079	AY28X079
Rubber Isolator Kit	BAYISLT101	BAYISLT101	BAYISLT101
Extreme Condition Mount Kit	BAYECMT023	BAYECMT023	BAYECMT023
Start Kit	BAYKSKT263	BAYKSKT263	BAYKSKT263
Crankcase Heater Kit	BAYCCHT302	BAYCCHT302	BAYCCHT302
Seacoast Kit	BAYSEAC001	BAYSEAC001	BAYSEAC001
Low Ambient Kit	BAYLOAM103	BAYLOAM103	BAYLOAM103
Refrigerant Lineset ^(d)			
Service Valve Panel Cover	TAYSVPANL0022AA	TAYSVPANL0022AA	TAYSVPANL0022AA

^(a) Certified in accordance with the Unitary Air-conditioner equipment certification program which is based on AHRI standard 210/240.

^(b) Calculated in accordance with N.E.C. Only use HACR circuit breakers or fuses.

^(c) Standard line lengths — 60', Standard lift — 60' Suction and Liquid line. For Greater lengths and lifts refer to refrigerant piping software Pub#32-3312-0* (* denotes latest revision).

^(d) 25, 30, 35 and 50 foot linesets available. For a complete listing of lineset options available from equipment or supply stores, refer to the American Standard Quick Reference Guide.

Product Specifications

Model No. ^(a)	4A7A4025N1000A\ 4A7A4025N1000B	4A7A4030N1000A	4A7A4036N1000A
POWER CONNS. — V/PH/HZ ^(b)	208/230/1/60	208/230/1/60	208/230/1/60
MIN. BRCH. CIR. AMPACITY	13 / 14	16	16
BR. CIR. PROT. RTG. — MAX. (AMPS)	20 / 25	25	25
COMPRESSOR	DURATION™ - SCROLL	DURATION™ - SCROLL	DURATION™ - SCROLL
RL AMPS — LR AMPS	10.1 — 52 / 10.9 — 62.9	12.2 — 80.1	12.2 — 80.1
Outdoor Fan FL AMPS	0.64	0.77	0.77
Fan HP	1/8	1/8	1/8
Fan Dia (inches)	23	23	23
Coil	SPINE FIN™	SPINE FIN™	SPINE FIN™
Refrigerant R-410A	4 LBS., 11 OZ	5 LBS., 11 OZ	5 LBS., 11 OZ
VALVE CONNECTION SIZE - IN. O.D. GAS	3/4	3/4	3/4
VALVE CONNECTION SIZE - IN. O.D. LIQ	3/8	3/8	3/8
LINE SIZE — IN. O.D. GAS ^(c)	3/4	3/4	3/4
LINE SIZE — IN. O.D. LIQ. ^(c)	3/8	3/8	3/8
Charge Spec. Subcooling	8°F	10°F	10°F
Dimensions H x W X D Crated (IN.)	34 x 30.1 x 33	38 x 30.1 x 33	38 x 30.1 x 33
Weight — Shipping (lbs.)	190	183	183
Weight — Net (lbs.)	162	156	156
Optional Accessories:			
Anti-short Cycle Timer	TAYASCT501A	TAYASCT501A	TAYASCT501A
Evaporator Defrost Control	AY28X079	AY28X079	AY28X079
Rubber Isolator Kit	BAYISLT101	BAYISLT101	BAYISLT101
Extreme Condition Mount Kit	BAYECMT023	BAYECMT023	BAYECMT023
Start Kit	BAYKSKT263	BAYKSKT263	BAYKSKT263
Crankcase Heater Kit	BAYCCHT302	BAYCCHT302	BAYCCHT302
Seacoast Kit	BAYSEAC001	BAYSEAC001	BAYSEAC001
Low Ambient Kit	BAYLOAM103	BAYLOAM103	BAYLOAM103
Refrigerant Lineset ^(d)			
Service Valve Panel Cover	TAYSVPANL0022AA	TAYSVPANL0032AA	TAYSVPANL3343AA

- ^(a) Certified in accordance with the Unitary Air-conditioner equipment certification program which is based on AHRI standard 210/240.
- ^(b) Calculated in accordance with N.E.C. Only use HACR circuit breakers or fuses.
- ^(c) Standard line lengths — 60', Standard lift — 60' Suction and Liquid line. For Greater lengths and lifts refer to refrigerant piping software Pub#32-3312-0* (* denotes latest revision).
- ^(d) 25, 30, 35 and 50 foot linesets available. For a complete listing of lineset options available from equipment or supply stores, refer to the American Standard Quick Reference Guide.

Product Specifications

Model No. ^(a)	4A7A4042N1000A	4A7A4048N1000A	4A7A4049N1000A	4A7A4060N1000A
POWER CONNS. — V/PH/Hz ^(b)	208/230/1/60	208/230/1/60	208/230/1/60	208/230/1/60
MIN. BRCH. CIR. AMPACITY	20	24	24	28
BR. CIR. PROT. RTG. — MAX. (AMPS)	35	40	40	50
COMPRESSOR	DURATION™ - SCROLL	DURATION™ - SCROLL	DURATION™ - SCROLL	DURATION™ - SCROLL
RL AMPS — LR AMPS	15.4 — 92.1	18.5 — 124	18.5 — 124	21.9 — 118.7
Outdoor Fan FL AMPS	1.05	1.05	0.93	0.97
Fan HP	1/5	1/5	1/5	1/5
Fan Dia (inches)	27.5	27.5	27.5	27.5
Coil	SPINE FIN™	SPINE FIN™	SPINE FIN™	SPINE FIN™
Refrigerant R-410A	6 LBS., 6 OZ	5 LBS., 3 OZ	7 LBS., 2 OZ	9 LBS., 8 OZ
VALVE CONNECTION SIZE - IN. O.D. GAS	3/4	7/8	7/8	7/8
VALVE CONNECTION SIZE - IN. O.D. LIQ	3/8	3/8	3/8	3/8
LINE SIZE — IN. O.D. GAS ^(c)	7/8	7/8	7/8	1-1/8
LINE SIZE — IN. O.D. LIQ. ^(c)	3/8	3/8	3/8	3/8
Charge Spec. Subcooling	10°F	10°F	8°F	10°F
Dimensions H x W X D Crated (IN.)	42 x 35.1 x 38.7	34.4 x 35.1 x 38.7	50.4 x 35.1 x 38.7	50.4 x 35.1 x 38.7
Weight — Shipping (lbs.)	246	212	306	302
Weight — Net (lbs.)	212	189	256	277
Optional Accessories:				
Anti-short Cycle Timer	TAYASCT501A	TAYASCT501A	TAYASCT501A	TAYASCT501A
Evaporator Defrost Control	AY28X079	AY28X079	AY28X079	AY28X079
Rubber Isolator Kit	BAYISLT101	BAYISLT101	BAYISLT101	BAYISLT101
Extreme Condition Mount Kit	BAYECMT004	BAYECMT004	BAYECMT004	BAYECMT004
Start Kit	BAYKSKT263	BAYKSKT263	BAYKSKT263	BAYKSKT263
Crankcase Heater Kit	BAYCCHT301	BAYCCHT301	BAYCCHT301	BAYCCHT301
Seacoast Kit	BAYSEAC001	BAYSEAC001	BAYSEAC001	BAYSEAC001
Low Ambient Kit	BAYLOAM103	BAYLOAM103	BAYLOAM103	BAYLOAM103
Refrigerant Lineset ^(d)				
Service Valve Panel Cover			TAYSVPANL0044AA	TAYSVPANL0044AA

^(a) Certified in accordance with the Unitary Air-conditioner equipment certification program which is based on AHRI standard 210/240.

^(b) Calculated in accordance with N.E.C. Only use HACR circuit breakers or fuses.

^(c) Standard line lengths — 60', Standard lift — 60' Suction and Liquid line. For Greater lengths and lifts refer to refrigerant piping software Pub#32-3312-0* (* denotes latest revision).

^(d) 25, 30, 35 and 50 foot linesets available. For a complete listing of lineset options available from equipment or supply stores, refer to the American Standard Quick Reference Guide.

Product Specifications

Model No. ^(a)	4A7A4018L1000A	4A7A4024L1000A/ 4A7A4025L1000B	4A7A4030L1000A/ 4A7A4030L1000B
POWER CONNS. — V/PH/HZ ^(b)	208/230/1/60	208/230/1/60	208/230/1/60
MIN. BRCH. CIR. AMPACITY	12	14	17 / 14
BR. CIR. PROT. RTG. — MAX. (AMPS)	20	25 / 20	25
COMPRESSOR	DURATION™ - SCROLL	DURATION™ - SCROLL	DURATION™ - SCROLL
RL AMPS — LR AMPS	9 — 63	10.1 — 52	12.8 — 68 / 10.9 — 62.6
Outdoor Fan FL AMPS	0.60	0.90	0.77
Fan HP	1/15	1/8	1/8
Fan Dia (inches)	18.2	18.2	23.0
Coil	SPINE FIN™	SPINE FIN™	SPINE FIN™
Refrigerant R-410A	4 LBS., 2 OZ	4 LBS., 11 OZ / 4 LBS., 2 OZ	4 LBS., 11 OZ
LINE SIZE — IN. O.D. GAS ^(c)	3/4	3/4	3/4
LINE SIZE — IN. O.D. LIQ. ^(c)	3/8	3/8	3/8
Charge Spec. Subcooling	10°F	10°F	10°F
Dimensions H x W X D Crated (IN.)	30.1 x 26.7 x 30	30.1 x 26.7 x 30	34 x 30.1 x 33
Weight — Shipping (lbs.)	153	153	183
Weight — Net (lbs.)	133	133	156
Optional Accessories:			
Anti-short Cycle Timer	TAYASCT501A	TAYASCT501A	TAYASCT501A
Evaporator Defrost Control	AY28X079	AY28X079	AY28X079
Rubber Isolator Kit	BAYISLT101	BAYISLT101	BAYISLT101
Extreme Condition Mount Kit	BAYECMT023	BAYECMT023	BAYECMT023
Start Kit	BAYKSKT263	BAYKSKT263	BAYKSKT263
Crankcase Heater Kit	BAYCCHT302	BAYCCHT302	BAYCCHT302
Seacoast Kit	BAYSEAC001	BAYSEAC001	BAYSEAC001
Low Ambient Kit	BAYLOAM103	BAYLOAM103	BAYLOAM103
Refrigerant Lineset ^(d)			
Service Valve Panel Cover	TAYSVPANL0022AA	TAYSVPANL0022AA	TAYSVPANL0032AA

- (a) Certified in accordance with the Unitary Air-conditioner equipment certification program which is based on AHRI standard 210/240.
- (b) Calculated in accordance with N.E.C. Only use HACR circuit breakers or fuses.
- (c) Standard line lengths — 60', Standard lift — 60' Suction and Liquid line. For Greater lengths and lifts refer to refrigerant piping software Pub#32-3312-0* (* denotes latest revision).
- (d) 25, 30, 35 and 50 foot linesets available. For a complete listing of lineset options available from equipment or supply stores, refer to the American Standard Quick Reference Guide.

Product Specifications

Model No. ^(a)	4A7A4031L1000A/ 4A7A4031L1000B	4A7A4036L1000A/ 4A7A4036L1000B	4A7A4037L1000A/ 4A7A4037L1000B
POWER CONNS. — V/PH/HZ ^(b)	208/230/1/60	208/230/1/60	208/230/1/60
MIN. BRCH. CIR. AMPACITY	17 / 14	18	18
BR. CIR. PROT. RTG. — MAX. (AMPS)	25	30	30
COMPRESSOR	DURATION™ - SCROLL	DURATION™ - SCROLL	DURATION™ - SCROLL
RL AMPS — LR AMPS	12.8 — 68 / 10.9 — 62.6	14.1 — 72 / 13.6 — 79	14.1 — 72 / 13.6 — 79
Outdoor Fan FL AMPS	0.64	0.77	0.64
Fan HP	1/8	1/8	1/8
Fan Dia (inches)	23.0	23.0	23.0
Coil	SPINE FIN™	SPINE FIN™	SPINE FIN™
Refrigerant R-410A	4 LBS., 11 OZ	5 LBS., 8 OZ	5 LBS., 3 OZ
LINE SIZE — IN. O.D. GAS ^(c)	3/4	3/4	3/4
LINE SIZE — IN. O.D. LIQ. ^(c)	3/8	3/8	3/8
Charge Spec. Subcooling	10°F	10°F	8°F
Dimensions H x W X D Crated (IN.)	34 x 30.1 x 33	38 x 30.1 x 33	38 x 30.1 x 33
Weight — Shipping (lbs.)	183	183	183
Weight — Net (lbs.)	156	156	156
Optional Accessories:			
Anti-short Cycle Timer	TAYASCT501A	TAYASCT501A	TAYASCT501A
Evaporator Defrost Control	AY28X079	AY28X079	AY28X079
Rubber Isolator Kit	BAYISLT101	BAYISLT101	BAYISLT101
Extreme Condition Mount Kit	BAYECMT023	BAYECMT023	BAYECMT023
Start Kit	BAYKSKT263	BAYKSKT263	BAYKSKT263
Crankcase Heater Kit	BAYCCHT302	BAYCCHT302	BAYCCHT302
Seacoast Kit	BAYSEAC001	BAYSEAC001	BAYSEAC001
Low Ambient Kit	BAYLOAM103	BAYLOAM103	BAYLOAM103
Refrigerant Lineset ^(d)			
Service Valve Panel Cover	TAYSVPANL0032AA	TAYSVPANL3343AA	TAYSVPANL3343AA

^(a) Certified in accordance with the Unitary Air-conditioner equipment certification program which is based on AHRI standard 210/240.
^(b) Calculated in accordance with N.E.C. Only use HACR circuit breakers or fuses.
^(c) Standard line lengths — 60', Standard lift — 60' Suction and Liquid line. For Greater lengths and lifts refer to refrigerant piping software Pub#32-3312-0* (* denotes latest revision).
^(d) 25, 30, 35 and 50 foot linesets available. For a complete listing of lineset options available from equipment or supply stores, refer to the American Standard Quick Reference Guide.

Product Specifications

Model No. ^(a)	4A7A4036M1000A/ 4A7A4037M1000A	4A7A4042L1000A/ 4A7A4043L1000A	4A7A4048L1000A	4A7A4060L1000A
POWER CONNS. — V/PH/HZ ^(b)	208/230/1/60	280/230/1/60	280/230/1/60	280/230/1/60
MIN. BRCH. CIR. AMPACITY	16	22	24	27
BR. CIR. PROT. RTG. — MAX. (AMPS)	25	35	40	50
COMPRESSOR	DURATION™ - SCROLL	DURATION™ - SCROLL	DURATION™ - SCROLL	DURATION™ - SCROLL
RL AMPS — LR AMPS	12.2 — 80.1	16.7 — 109	18.5 — 124	20.8 — 127.1
Outdoor Fan FL AMPS	0.64	1.05	1.05	1.05
Fan HP	1/8	1/5	1/5	1/5
Fan Dia (inches)	23.0	27.5	27.5	27.5
Coil	SPINE FIN™	SPINE FIN™	SPINE FIN™	SPINE FIN™
Refrigerant R-410A	5 LBS., 2 OZ	6 LBS., 2 OZ / 5 LBS., 5 OZ	5 LBS., 3 OZ	7 LBS., 10 OZ
LINE SIZE — IN. O.D. GAS ^(c)	3/4	7/8	7/8	7/8
LINE SIZE — IN. O.D. LIQ. ^(c)	3/8	3/8	3/8	3/8
Charge Spec. Subcooling	10°F	12°F	10°F	10°F
Dimensions H x W X D Crated (IN.)	34 x 30.1 x 33	34.4 x 35.1 x 38.7	34.4 x 35.1 x 38.7	42.4 x 35.1 x 38.7
Weight — Shipping (lbs.)	189	216	212	246
Weight — Net (lbs.)	161	184	189	211
Optional Accessories:				
Anti-short Cycle Timer	TAYASCT501A	TAYASCT501A	TAYASCT501A	TAYASCT501A
Evaporator Defrost Control	AY28X079	AY28X079	AY28X079	AY28X079
Rubber Isolator Kit	BAYISLT101	BAYISLT101	BAYISLT101	BAYISLT101
Extreme Condition Mount Kit	BAYECMT023	BAYECMT004	BAYECMT004	BAYECMT004
Start Kit	BAYKSKT263	BAYKSKT263	BAYKSKT263	BAYKSKT263
Crankcase Heater Kit	BAYCCHT302	BAYCCHT301	BAYCCHT301	BAYCCHT301
Seacoast Kit	BAYSEAC001	BAYSEAC001	BAYSEAC001	BAYSEAC001
Low Ambient Kit	BAYLOAM103	BAYLOAM103	BAYLOAM103	BAYLOAM103
Refrigerant Lineset ^(d)				
Service Valve Panel Cover	TAYSVPANL3343AA			TAYSVPANL0044AA

^(a) Certified in accordance with the Unitary Air-conditioner equipment certification program which is based on AHRI standard 210/240.

^(b) Calculated in accordance with N.E.C. Only use HACR circuit breakers or fuses.

^(c) Standard line lengths — 60', Standard lift — 60' Suction and Liquid line. For Greater lengths and lifts refer to refrigerant piping software Pub#32-3312-0* (* denotes latest revision).

^(d) 25, 30, 35 and 50 foot linesets available. For a complete listing of lineset options available from equipment or supply stores, refer to the American Standard Quick Reference Guide.

Product Specifications

Sound Power Level

Sound Power Level									
MODEL	A-Weighted Sound Power Level [dB(A)]	Full Octave Sound Power(dB)							
		63 Hz*	125 Hz	250 Hz	500 Hz	1000 Hz	2000 Hz	4000 Hz	8000 Hz
4A7A4018N1	71	74	71	65	68	67	63	56	50
4A7A4019N1	73	79	69	67	70	70	64	59	53
4A7A4024N1	71	74	71	65	68	67	63	56	50
4A7A4025N1	73	79	69	67	70	70	64	59	53
4A7A4030N1	71	78	72	69	68	66	61	58	53
4A7A4036N1	71	78	72	69	68	66	61	58	53
4A7A4042N1	72	81	75	71	70	68	63	58	53
4A7A4048N1	71	81	72	69	69	66	60	57	54
4A7A4049N1	72	81	75	71	70	68	63	58	53
4A7A4060N1	72	81	75	71	70	68	63	58	53

Note: Rated in accordance with AHRI Standard 270-2008 *For Reference Only

Sound Power Level									
MODEL	A-Weighted Sound Power Level [dB(A)]	Full Octave Sound Power(dB)							
		63 Hz*	125 Hz	250 Hz	500 Hz	1000 Hz	2000 Hz	4000 Hz	8000 Hz
4A7A4018L1	71	74	71	65	68	67	63	56	50
4A7A4024L1 4A7A4025L1	71	74	71	65	68	67	63	56	50
4A7A4030L1 4A7A4031L1	71	73	73	72	69	68	60	52	45
4A7A4036L1 4A7A4037L1	71	73	73	72	69	68	60	52	45
4A7A4036M1 4A7A4037M1	71	73	73	72	69	68	60	52	45
4A7A4042L1 4A7A4043L1	71	81	72	69	69	66	60	57	54
4A7A4048L1	71	81	72	69	69	66	60	57	54
4A7A4060L1	71	81	72	69	69	66	60	57	54

Note: Rated in accordance with AHRI Standard 270-2008 *For Reference Only

Accessory Description and Usage

Anti-Short Cycle Timer — Solid state timing device that prevents compressor recycling until five (5) minutes have elapsed after satisfying call or power interruptions. Use in area with questionable power delivery, commercial applications, long lineset, etc.

Evaporation Defrost Control — SPST Temperature actuated switch that cycles the condenser off as indoor coil reaches freeze-up conditions. Used for low ambient cooling to 30°F with TXV.

Rubber Isolators — Five (5) large rubber donuts to isolate condensing unit from transmitting energy into mounting frame or pad. Use on any application where sound transmission needs to be minimized.

Hard Start Kit — Start capacitor and relay to assist compressor motor startup. Use in areas with marginal power supply, on long linesets, low ambient conditions, etc.

Extreme Condition Mount Kit — Bracket kits to securely mount condensing unit to a frame or pad without removing any panels. Use in areas with high winds, or on commercial roof tops, etc.

AHRI Standard Capacity Rating Conditions

AHRI Standard 210/240 Rating Conditions

1. Cooling 80°F DB, 67°F WB air entering indoor coil, 95°F DB air entering outdoor coil.
2. High Temperature Heating 47°F DB, 43°F WB air entering outdoor coil, 70°F DB air entering indoor coil.
3. Low Temperature Heating 17°F DB air entering indoor coil.
4. Rated indoor airflow for heating is the same as for cooling.

AHRI Standard 270 Rating Conditions — (Noise rating numbers are determined with the unit in cooling operations.) Standard Noise Rating number is at 95°F outdoor air.

Model Nomenclature

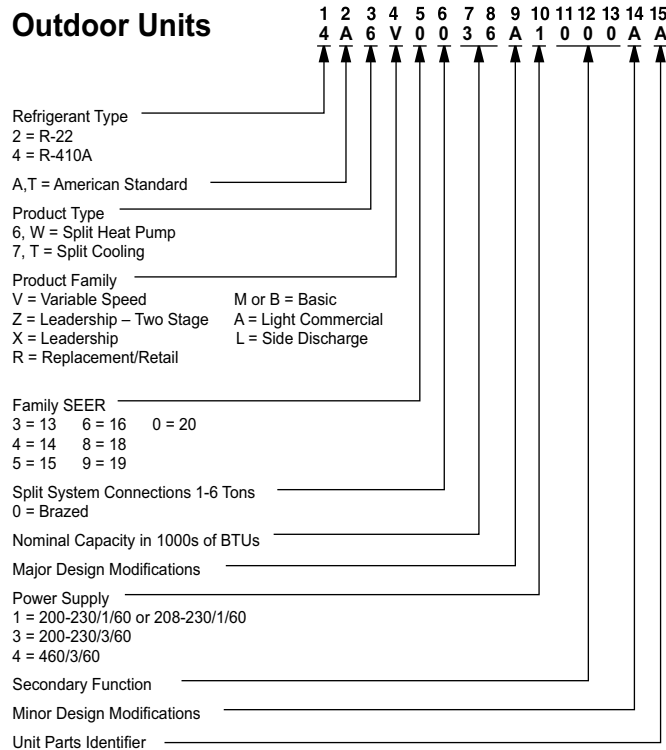

Schematic Diagrams

Figure 1. 018N, 019N, 024N, 025N, 042N & 049N Models

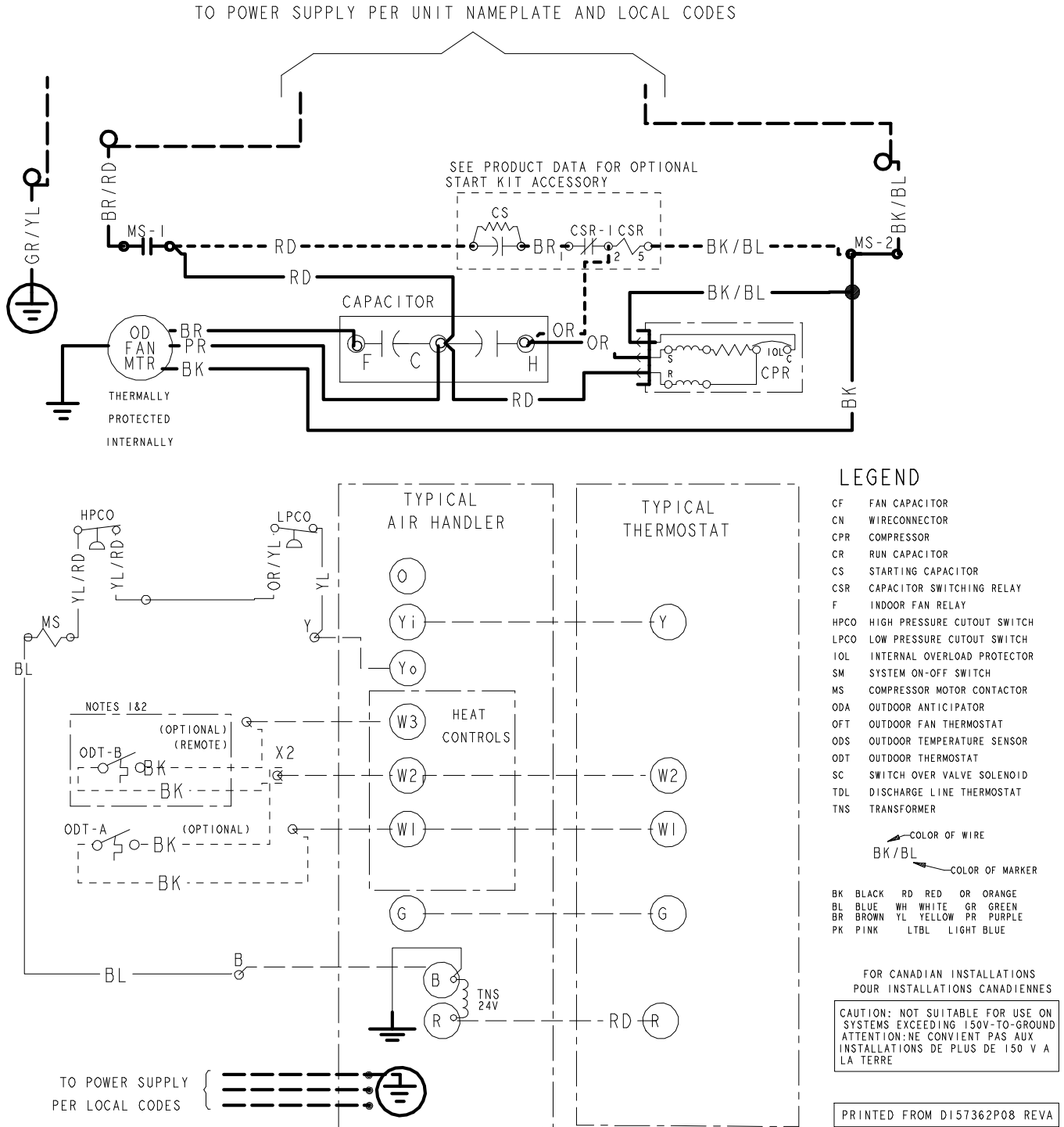

Figure 2. 018N, 019N, 024N, 025N, 042N & 049N Models

NOTES:

1. IF ODT-B IS NOT USED. ADD JUMPER BETWEEN W2 & W3 AT AIR HANDLER. IF USED, ODT-B MUST BE MOUNTED REMOTE OF CONTROL BOX IN AN APPROVED WEATHER PROOF ENCLOSURE.
2. IF ODT-A IS NOT USED. ADD JUMPER BETWEEN W1 & W2 AT AIR HANDLER.
3. LOW VOLTAGE (24 V) FIELD WIRING MUST BE 18 AWG MIN.

LEGEND

- 24 V } FACTORY WIRING
- LINE WIRING
- 24 V } FIELD WIRING
- LINE WIRING
- FIELD INSTALLED
- FACTORY WIRING
- MAGNETIC COIL
- GROUND
- JUNCTION
- CAPACITOR
- WIRE NUT OR
- TERMINAL
- TRANSFORMER
- FUSE
- TERMINAL BLOCK/BOARD
- RELAY CONTACT (N.O.)
- RELAY CONTACT (N.C.)
- THERMISTOR
- TEMP ACTUATED SWITCH
- INTERNAL OVERLOAD PROTECTION
- PRESSURE ACTUATED SWITCH
- RESISTOR OR HEATING ELEMENT
- MOTOR WINDING
- POL. PLUG FEMALE HOUSING (MALE TERMINALS)
- POL. PLUG MALE HOUSING (FEMALE TERMINALS)

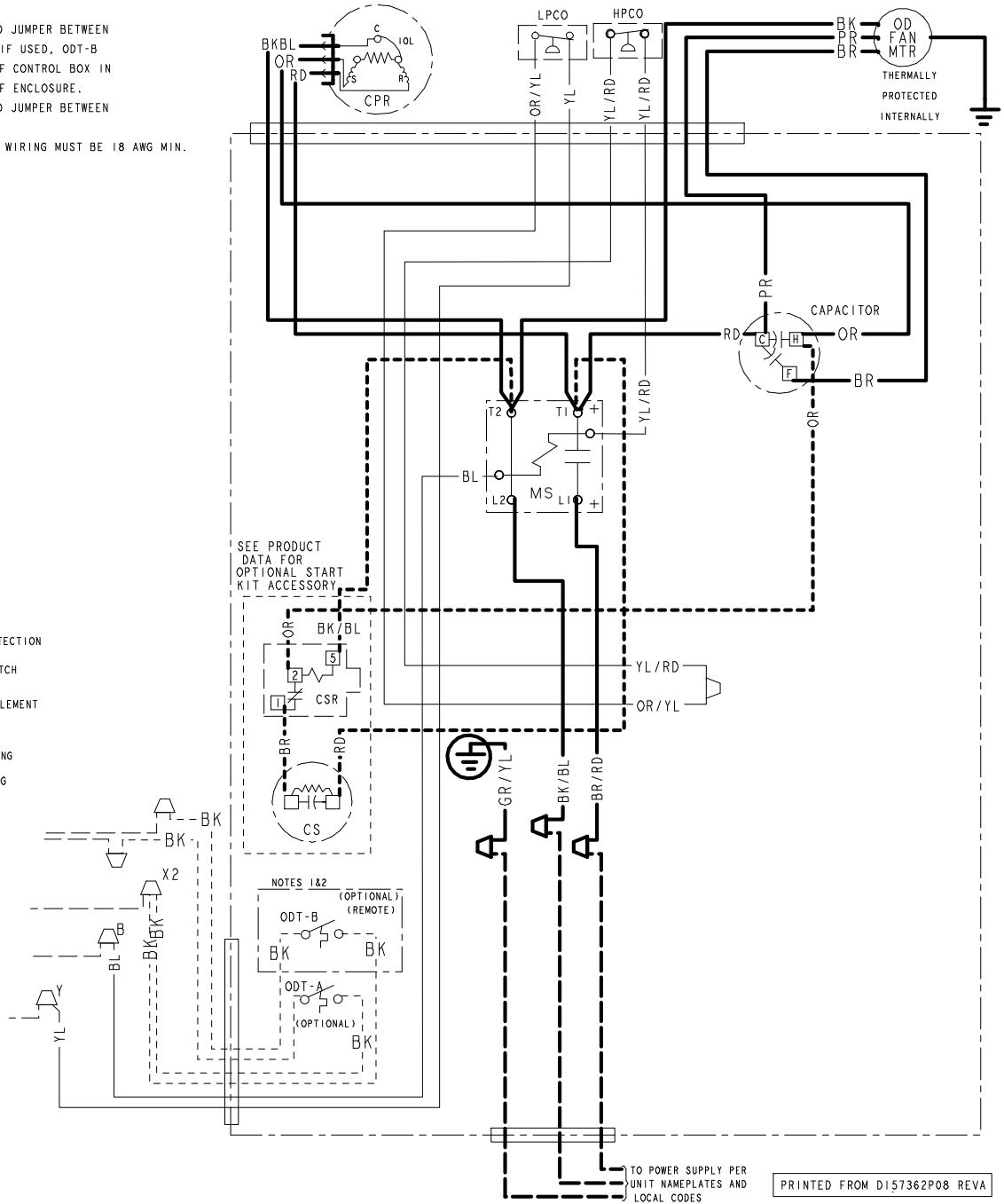

PRINTED FROM D157362P08 REVA

Schematic Diagrams

Figure 3. 030N, 036N & 048N Models
018L, 024/25L, 030/31L, 036/37L, 036/37M, 042/43L & 048L Models

TO POWER SUPPLY PER UNIT NAMEPLATE AND LOCAL CODES

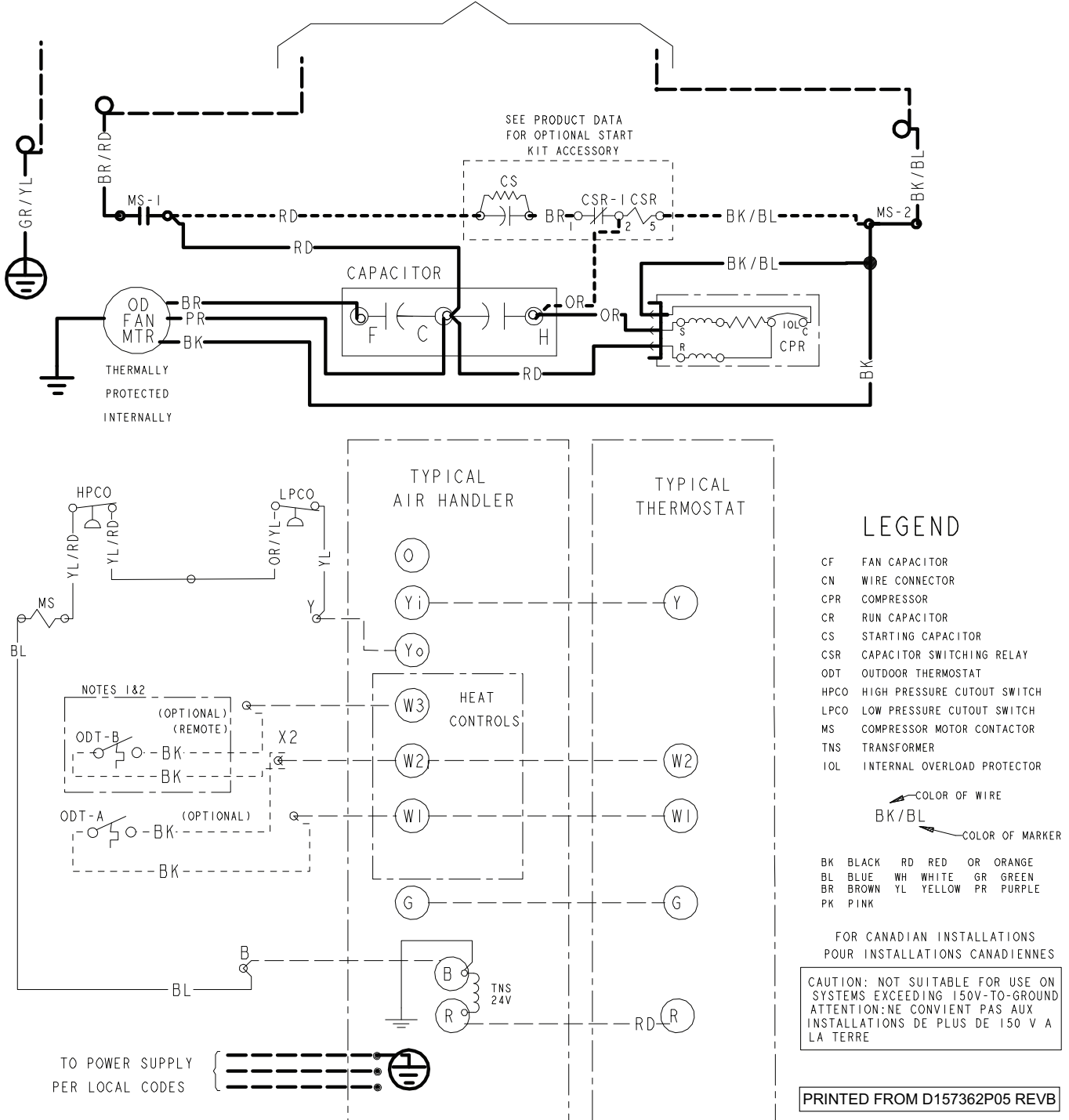

Figure 4. 030N, 036N & 048N Models
018L, 024/25L, 030/31L, 036/37L, 036/37M, 042/43L & 048L Models

NOTES:

1. IF ODT-B IS NOT USED. ADD JUMPER BETWEEN W2 & W3 AT AIR HANDLER. IF USED, ODT-B MUST BE MOUNTED REMOTE OF CONTROL BOX IN AN APPROVED WEATHER PROOF ENCLOSURE.
2. IF ODT-A IS NOT USED. ADD JUMPER BETWEEN W1 & W2 AT AIR HANDLER.
3. LOW VOLTAGE (24 V) FIELD WIRING MUST BE 18 AWG MINIMUM.
4. USE COPPER CONDUCTORS ONLY!

LEGEND

24 V } FACTORY LINE V } WIRING	RELAY CONTACT (N.O.)
24 V } FIELD LINE V } WIRING	RELAY CONTACT (N.C.)
FIELD INSTALLED FACTORY WIRING	THERMISTOR
MAGNETIC COIL	TEMP ACTUATED SWITCH
GROUND	INTERNAL OVERLOAD PROTECTION
JUNCTION	PRESSURE ACTUATED SWITCH
CAPACITOR	RESISTOR OR HEATING ELEMENT
WIRE NUT OR TERMINAL	MOTOR WINDING
TRANSFORMER	POL. PLUG FEMALE HOUSING (MALE TERMINALS)
TERMINAL BLOCK/BOARD	POL. PLUG MALE HOUSING (FEMALE TERMINALS)

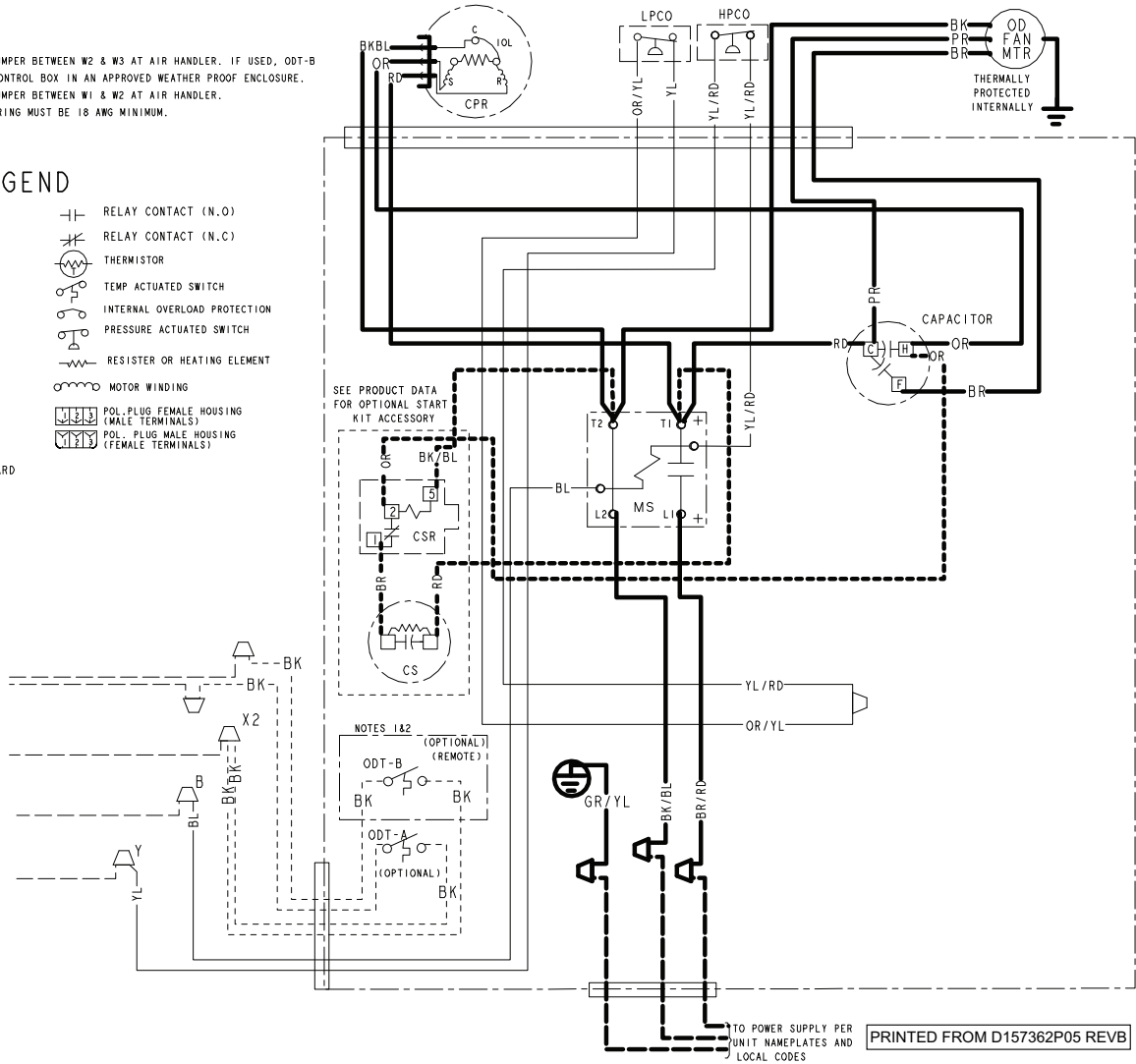

PRINTED FROM D157362P05 REV B

Schematic Diagrams

Figure 5. 060N Models

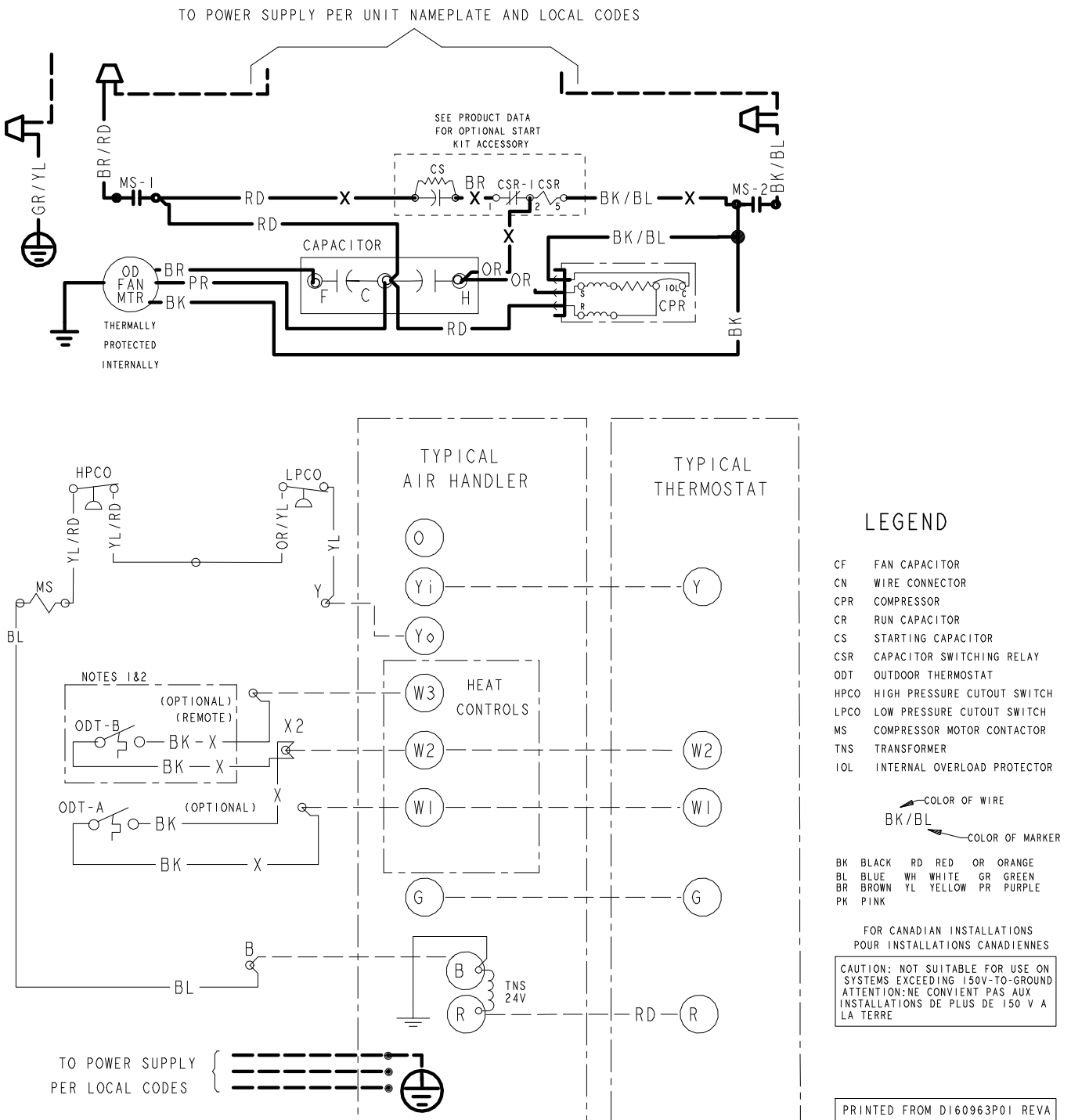

Figure 6. 060N Models

NOTES:

1. IF ODT-B IS NOT USED. ADD JUMPER BETWEEN W2 & W3 AT AIR HANDLER. IF USED, ODT-B MUST BE MOUNTED REMOTE OF CONTROL BOX IN AN APPROVED WEATHER PROOF ENCLOSURE.
2. IF ODT-A IS NOT USED. ADD JUMPER BETWEEN W1 & W2 AT AIR HANDLER.
3. LOW VOLTAGE (24 V) FIELD WIRING MUST BE 18 AWG MINIMUM.
4. USE COPPER CONDUCTORS ONLY!

LEGEND

- 24 V } FACTORY WIRING
- 24 V } FIELD WIRING
- 24 V } FIELD INSTALLED
- 24 V } FACTORY WIRING
- MAGNETIC COIL
- GROUND
- JUNCTION
- CAPACITOR
- WIRE NUT OR CONNECTOR
- TERMINAL
- TRANSFORMER
- TERMINAL BLOCK/BOARD
- RELAY CONTACT (N.O.)
- RELAY CONTACT (N.C.)
- THERMISTOR
- TEMP ACTUATED SWITCH
- INTERNAL OVERLOAD PROTECTION
- PRESSURE ACTUATED SWITCH
- RESISTOR OR HEATING ELEMENT
- MOTOR WINDING
- POL. PLUG FEMALE HOUSING (MALE TERMINALS)
- POL. PLUG MALE HOUSING (FEMALE TERMINALS)

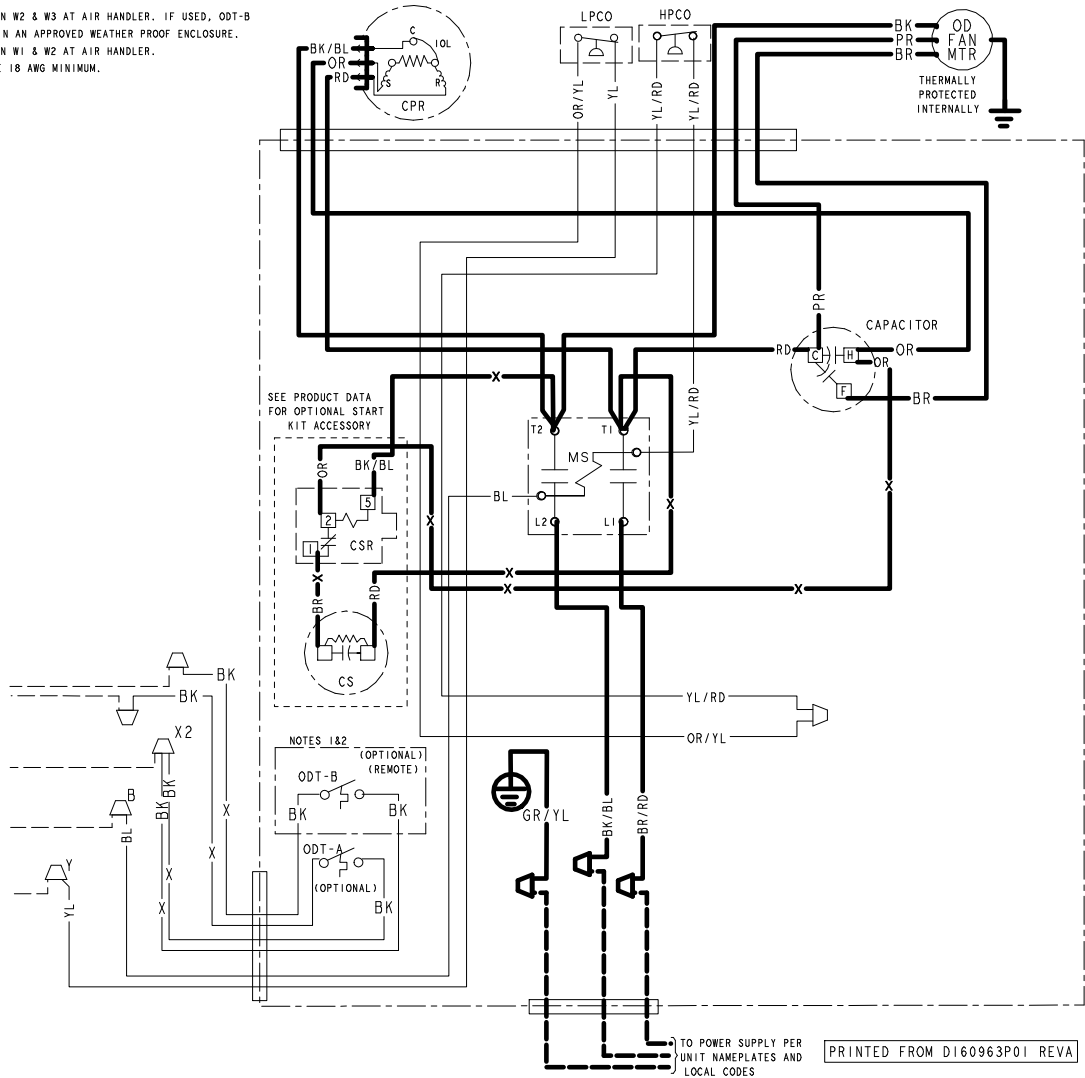

Schematic Diagrams

Figure 7. 060L Models

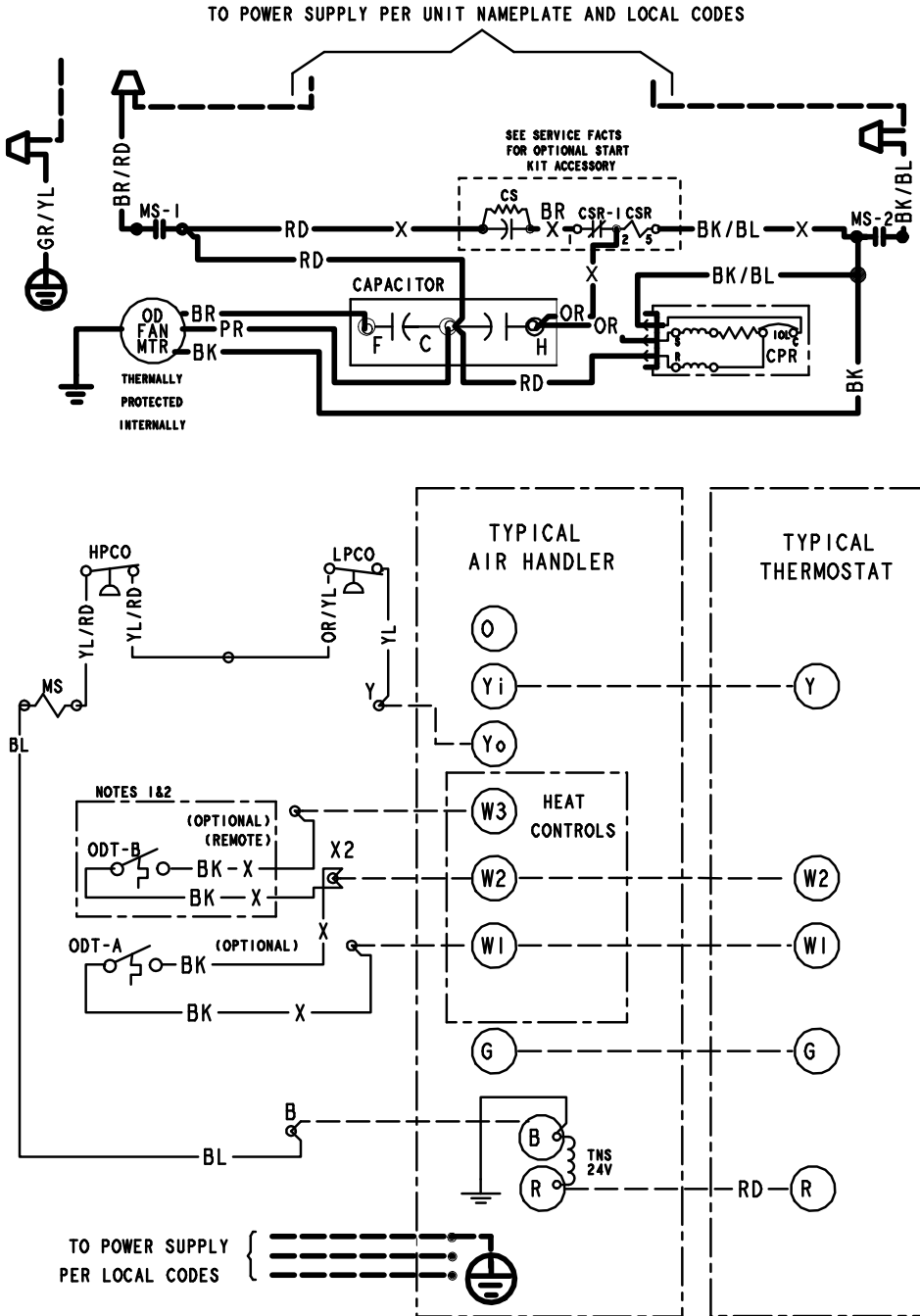

LEGEND

- CF FAN CAPACITOR
- CN WIRE CONNECTOR
- CPR COMPRESSOR
- CR RUN CAPACITOR
- CS STARTING CAPACITOR
- CSR CAPACITOR SWITCHING RELAY
- ODT OUTDOOR THERMOSTAT
- HPCO HIGH PRESSURE CUTOOUT SWITCH
- LPCO LOW PRESSURE CUTOOUT SWITCH
- MS COMPRESSOR MOTOR CONTACTOR
- TNS TRANSFORMER
- IOL INTERNAL OVERLOAD PROTECTOR

COLOR OF WIRE
BK/BL
COLOR OF MARKER

- BK BLACK RD RED OR ORANGE
- BL BLUE WH WHITE GR GREEN
- BR BROWN YL YELLOW PR PURPLE
- PK PINK

FOR CANADIAN INSTALLATIONS
POUR INSTALLATIONS CANADIENNES

CAUTION: NOT SUITABLE FOR USE ON SYSTEMS EXCEEDING 150V-TO-GROUND
ATTENTION: NE CONVIENT PAS AUX INSTALLATIONS DE PLUS DE 150 V A LA TERRE























PRINTED FROM DI60439P01 REVA

Figure 8. 060L Models

NOTES:

1. IF ODT-B IS NOT USED, ADD JUMPER BETWEEN W2 & W3 AT AIR HANDLER. IF USED, ODT-B MUST BE MOUNTED REMOTE OF CONTROL BOX IN AN APPROVED WEATHER PROOF ENCLOSURE.
2. IF ODT-A IS NOT USED, ADD JUMPER BETWEEN W1 & W2 AT AIR HANDLER.
3. LOW VOLTAGE (24 V) FIELD WIRING MUST BE 18 AWG MINIMUM.
4. USE COPPER CONDUCTORS ONLY!

LEGEND

 24 V FACTORY LINE WIRING	 RELAY CONTACT (N.O)
 24 V FIELD LINE WIRING	 RELAY CONTACT (N.C)
 24 V FIELD INSTALLED LINE WIRING	 THERMISTOR
 24 V FIELD INSTALLED LINE WIRING	 TEMP ACTUATED SWITCH
 MAGNETIC COIL	 INTERNAL OVERLOAD PROTECTION
 GROUND	 PRESSURE ACTUATED SWITCH
 JUNCTION	 RESISTOR OR HEATING ELEMENT
 CAPACITOR	 MOTOR WINDING
 WIRE NUT OR CONNECTOR	 POL. PLUG FEMALE HOUSING (MALE TERMINALS)
 TERMINAL	 POL. PLUG MALE HOUSING (FEMALE TERMINALS)
 TRANSFORMER	
 TERMINAL BLOCK/BOARD	

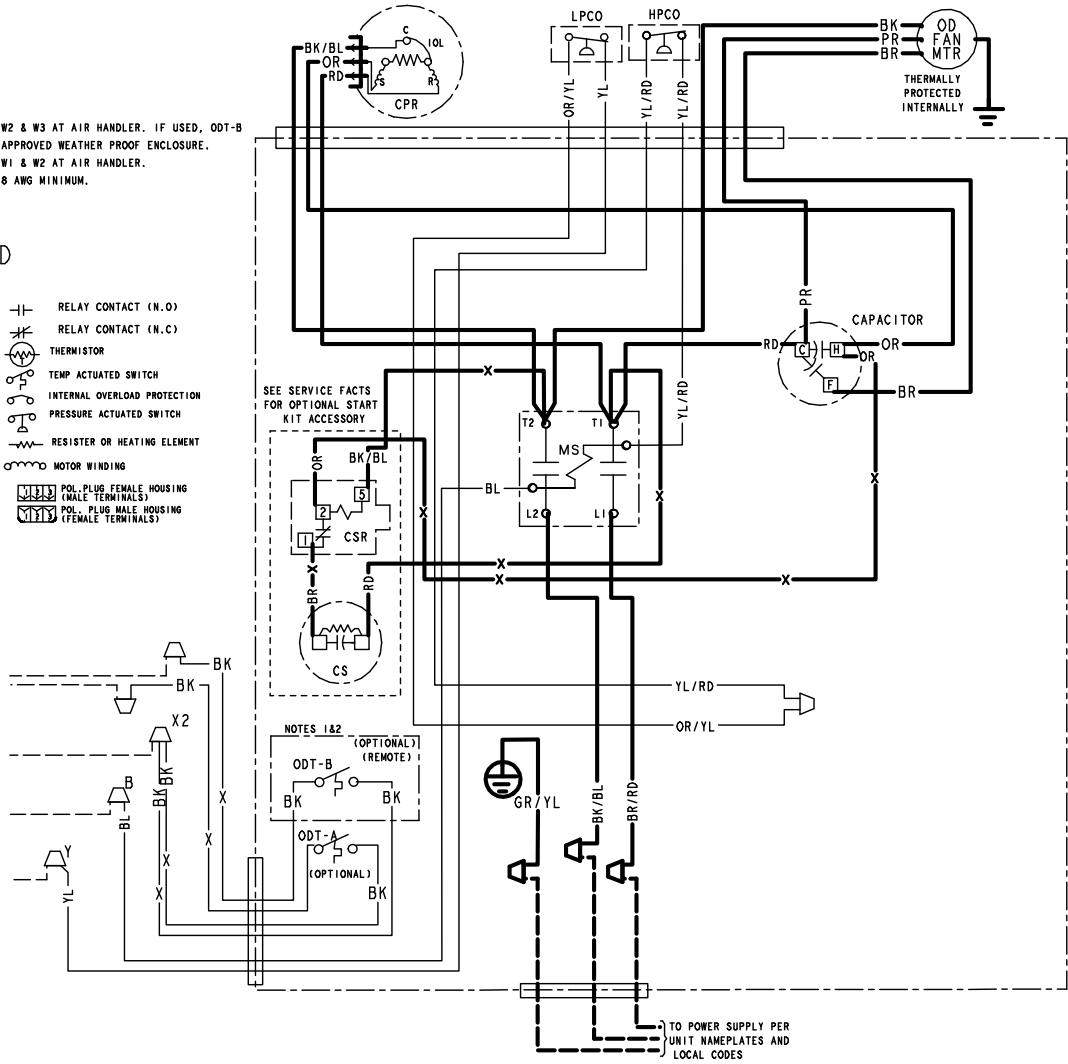

PRINTED FROM D160439P01 REVA

Outline Drawing

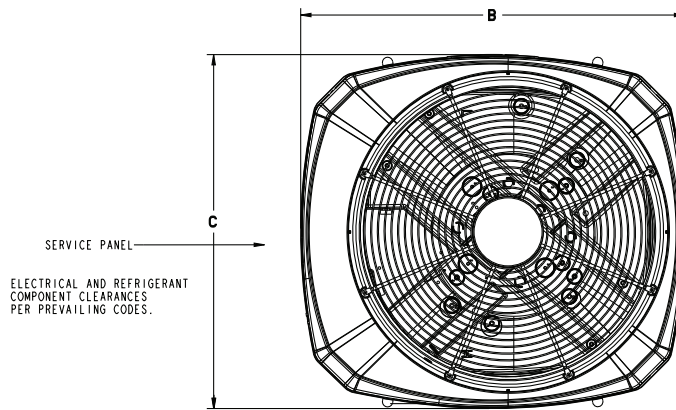

TOP DISCHARGE AREA SHOULD BE UNRESTRICTED FOR AT LEAST 1524 (5 FEET) ABOVE UNIT. UNIT SHOULD BE PLACED SO ROOF RUN-OFF WATER DOES NOT POUR DIRECTLY ON UNIT, AND SHOULD BE AT LEAST 305 (12") FROM WALL AND ALL SURROUNDING SHRUBBERY ON TWO SIDES. OTHER TWO SIDES UNRESTRICTED.

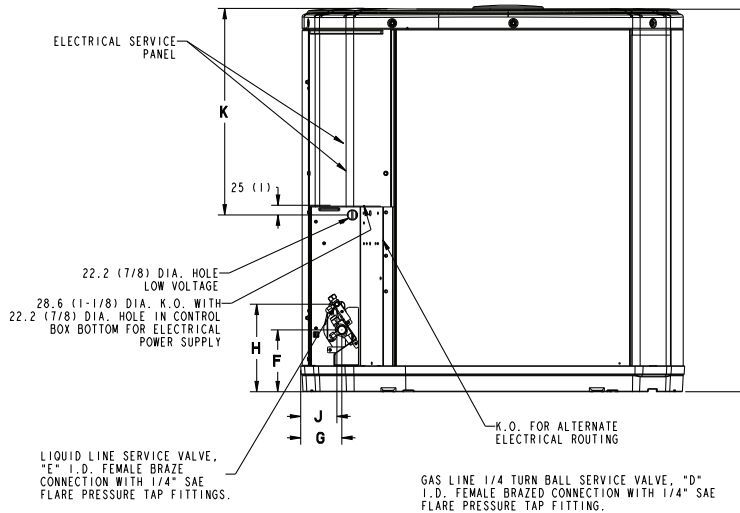

Model	Base	A	B	C	D	E	F	G	H	J	K
4A7A4018N	2	730 (28-3/4)	724 (28-1/2)	651 (25-5/8)	3/4	3/8	127 (5)	57 (2-1/4)	194 (7-5/8)	38 (1-1/2)	457 (18)
4A7A4019N	3	730 (28-3/4)	829 (32-5/8)	756 (29-3/4)	3/4	3/8	127 (5)	76 (3)	197 (7-3/4)	60 (2-3/8)	508 (20)
4A7A4024N	2	730 (28-3/4)	724 (28-1/2)	651 (25-5/8)	3/4	3/8	127 (5)	57 (2-1/4)	194 (7-5/8)	38 (1-1/2)	457 (18)
4A7A4025N	3	730 (28-3/4)	829 (32-5/8)	756 (29-3/4)	3/4	3/8	127 (5)	76 (3)	197 (7-3/4)	60 (2-3/8)	508 (20)
4A7A4030N	3	832 (32-3/4)	829 (32-5/8)	756 (29-3/4)	3/4	3/8	127 (5)	76 (3)	197 (7-3/4)	60 (2-3/8)	508 (20)
4A7A4036N	3	832 (32-3/4)	829 (32-5/8)	756 (29-3/4)	3/4	3/8	127 (5)	76 (3)	197 (7-3/4)	60 (2-3/8)	508 (20)
4A7A4042N	4	943 (37-1/8)	946 (37-1/4)	870 (34-1/4)	3/4	3/8	143 (5-5/8)	98 (3-7/8)	219 (8-5/8)	86 (3-3/8)	508 (20)
4A7A4048N	4	741 (29-1/8)	946 (37-1/4)	870 (34-1/4)	7/8	3/8	143 (5-5/8)	83 (3-1/4)	206 (8-1/8)	70 (2-3/4)	508 (20)
4A7A4049N	4	1147 (45-1/8)	946 (37-1/4)	870 (34-1/4)	7/8	3/8	152 (6)	98 (3-7/8)	219 (8-5/8)	86 (3-3/8)	508 (20)
4A7A4060N	4	1147 (45-1/8)	946 (37-1/4)	870 (34-1/4)	7/8	3/8	152 (6)	98 (3-7/8)	219 (8-5/8)	86 (3-3/8)	508 (20)

Outline Drawing

Model	Base	A	B	C	D	E	F	G	H	J	K
4A7A4018L	2	730 (28-3/4)	724 (28-1/2)	651 (25-5/8)	3/4	3/8	127 (5)	57 (2-1/4)	194 (7-5/8)	38 (1-1/2)	457 (18)
4A7A4024L 4A7A4025L	2	730 (28-3/4)	724 (28-1/2)	651 (25-5/8)	3/4	3/8	127 (5)	57 (2-1/4)	194 (7-5/8)	38 (1-1/2)	457 (18)
4A7A4030L 4A7A4031L	3	730 (28-3/4)	829 (32-5/8)	756 (29-3/4)	3/4	3/8	127 (5)	76 (3)	197 (7-3/4)	60 (2-3/8)	508 (20)
4A7A4036L 4A7A4037L	3	832 (32-3/4)	829 (32-5/8)	756 (29-3/4)	3/4	3/8	127 (5)	76 (3)	197 (7-3/4)	60 (2-3/8)	508 (20)
4A7A4036M 4A7A4037M	3	730 (28-3/4)	829 (32-5/8)	756 (29-3/4)	3/4	3/8	127 (5)	76 (3)	197 (7-3/4)	60 (2-3/8)	508 (20)
4A7A4042L 4A7A4043L	4	741 (29-1/8)	946 (37-1/4)	870 (34-1/4)	7/8	3/8	143 (5-5/8)	83 (3-1-4)	206 (8-1/8)	70 (2-3/4)	508 (20)
4A7A4048L	4	741 (29-1/8)	946 (37-1/4)	870 (34-1/4)	7/8	3/8	143 (5-5/8)	83 (3-1-4)	206 (8-1/8)	70 (2-3/4)	508 (20)
4A7A4060L	4	943 (37-1/8)	946 (37-1/4)	870 (34-1/4)	7/8	3/8	152 (6)	98 (3-7/8)	219 (8-5/8)	86 (3-3/8)	508 (20)

Mechanical Specification Options

General

The outdoor condensing units are factory charged with the system charge required for the outdoor condensing unit, ten (10) feet of tested connecting line, and the smallest rated indoor evaporative coil match. This unit is designed to operate at outdoor ambient temperatures as high as 115°F. Cooling capacities are matched with a wide selection of air handlers and furnace coils that are AHRI certified. The unit is certified to UL 1995. Exterior is designed for outdoor application.

Casing

Unit casing is constructed of heavy gauge, galvanized steel and painted with a weather-resistant powder paint finish. The corner panels are prepainted. All panels are subjected to our 1,000 hour salt spray test.

Refrigerant Controls

Refrigeration system controls include condenser fan, compressor contactor and low and high pressure switches. A factory supplied, field installed liquid line drier is standard.

Compressor

The compressor features internal over temperature and pressure protection. Other features include: Centrifugal oil pump and low vibration and noise.

Condenser Coil

The outdoor coil provides low airflow resistance and efficient heat transfer. The coil is protected on all four sides by louvered panels.

Low Ambient Cooling

As manufactured, this system has a cooling capacity to 55°F. The addition of an evaporator defrost control permits operation to 40°F. The addition of an evaporator defrost control with TXV permits low ambient cooling to 30°F.

The addition of the BAYLOAM107A low ambient kit permits ambient cooling to 20°F.

Thermostats – Cooling only and heat/cooling (manual and automatic change over). Sub-base to match thermostat and locking thermostat cover.

American Standard[®]
HEATING & AIR CONDITIONING

About American Standard Heating and Air Conditioning
American Standard has been creating comfortable and affordable living environments for more than a century. For more information, please visit www.americanstandardair.com.



The AHRI Certified mark indicates company participation in the AHRI Certification program. For verification of individual certified products, go to ahridirectory.org.

The manufacturer has a policy of continuous data improvement and it reserves the right to change design and specifications without notice. We are committed to using environmentally conscious print practices.